

# ASSEMBLY GUIDE

**ARENA MOTO** 

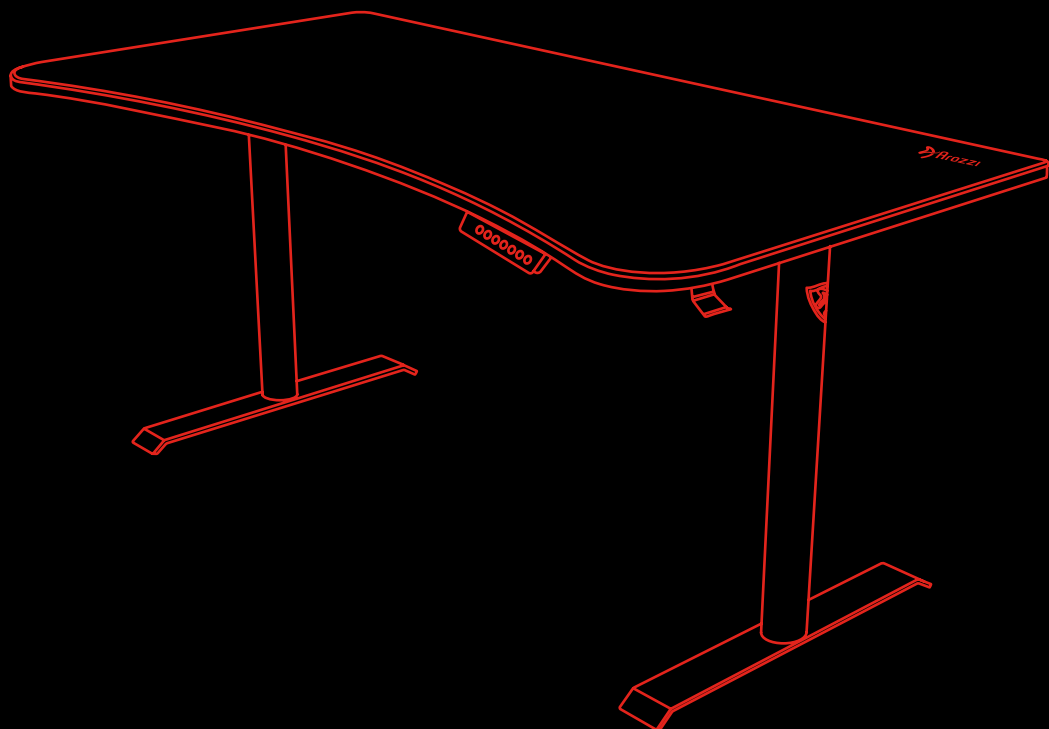

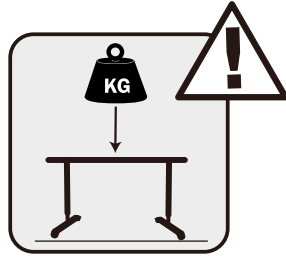

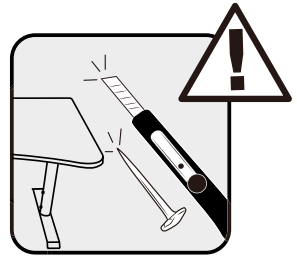
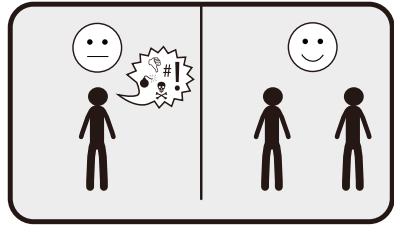
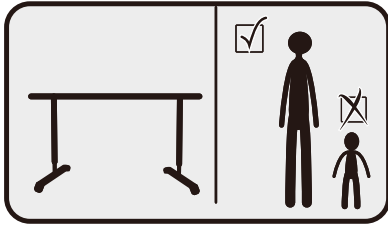
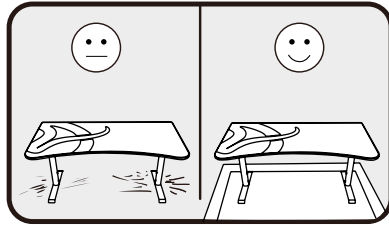
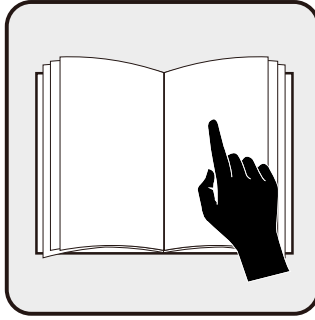
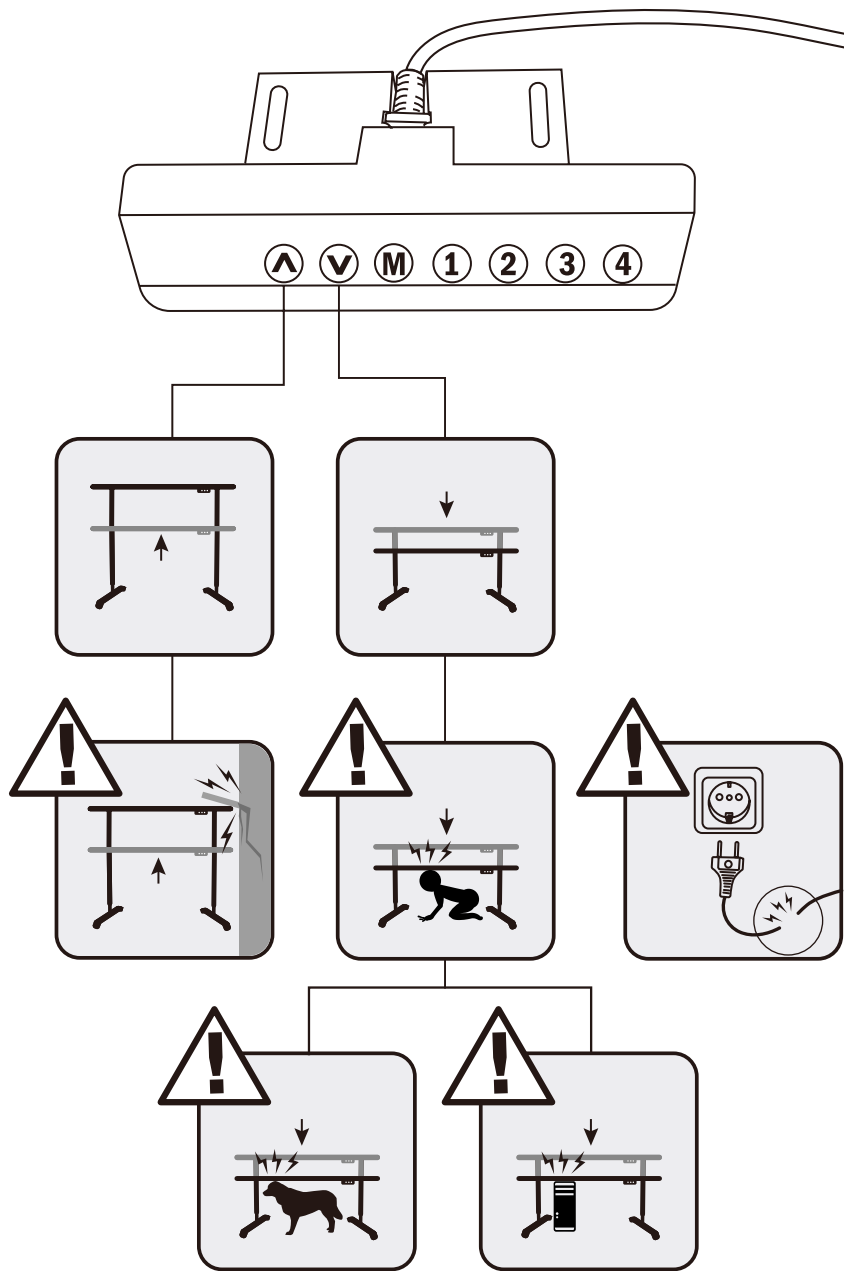

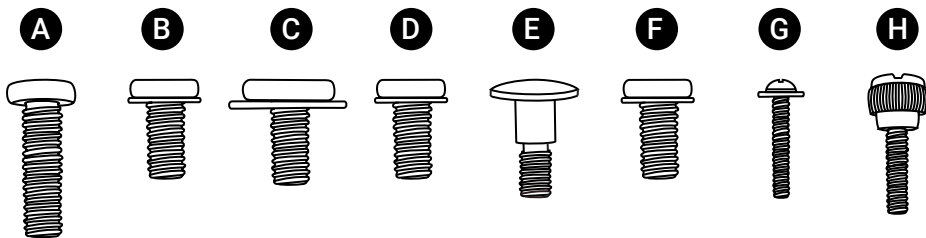

x8 x16 x8 x14 x10 x12 x4 x2

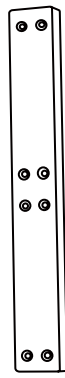
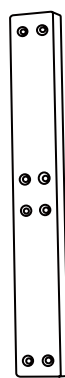
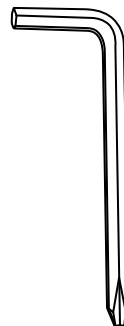
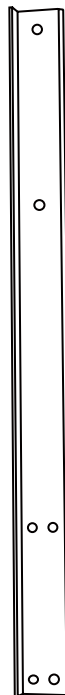
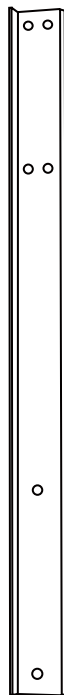
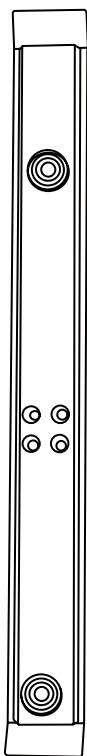
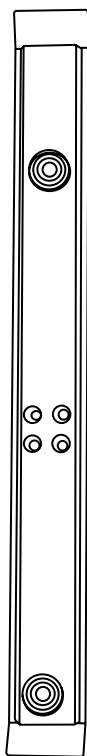

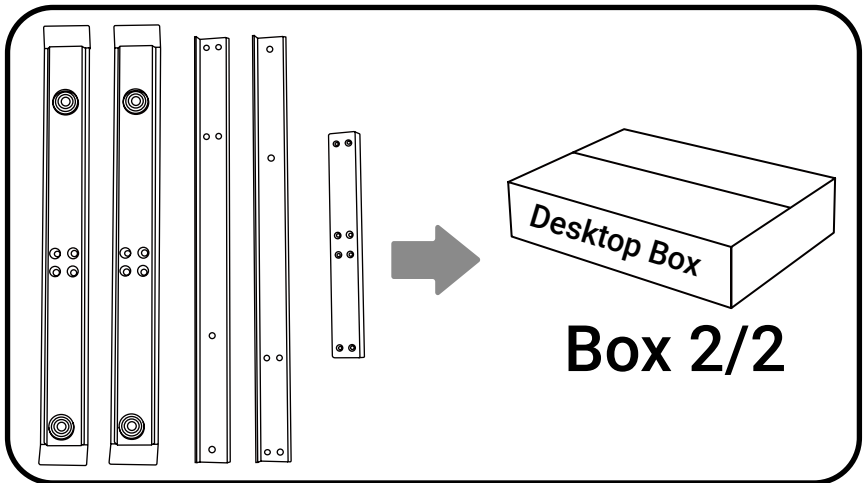
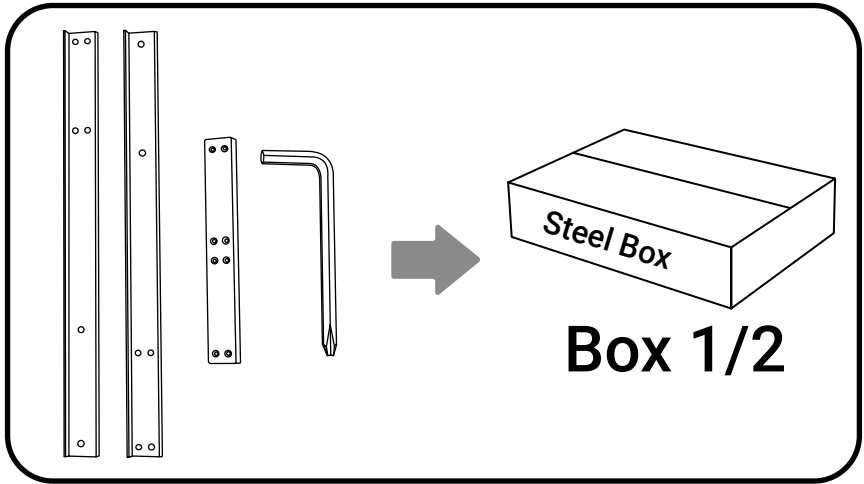

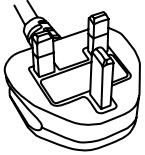
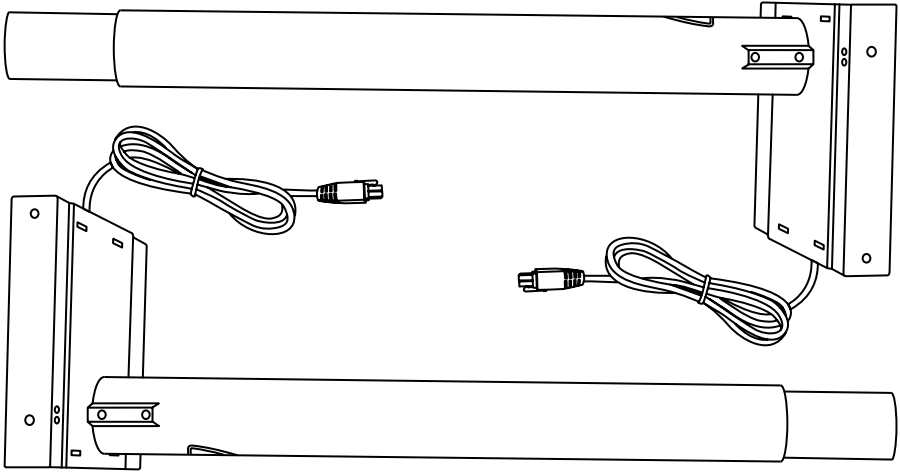

UK

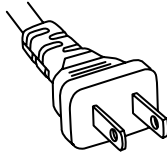

USA

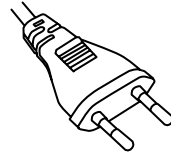

EU

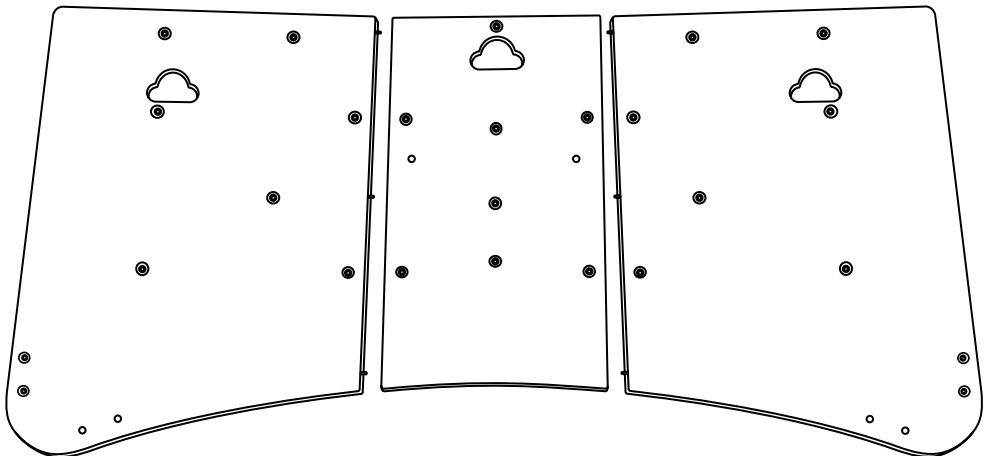

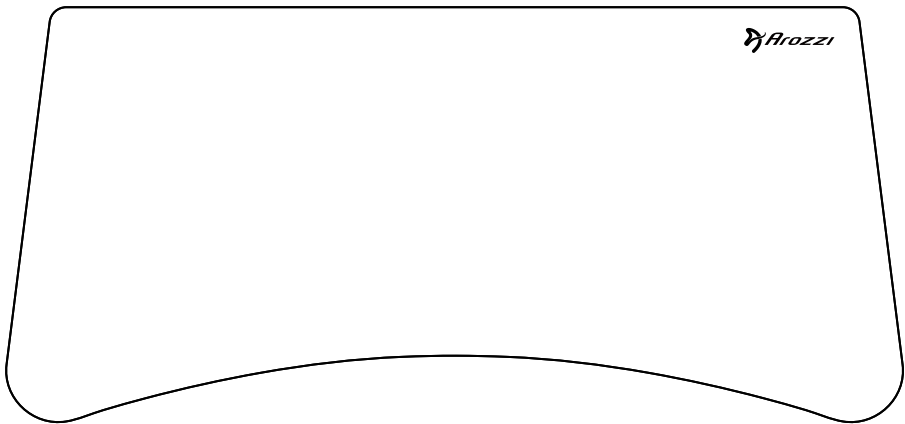
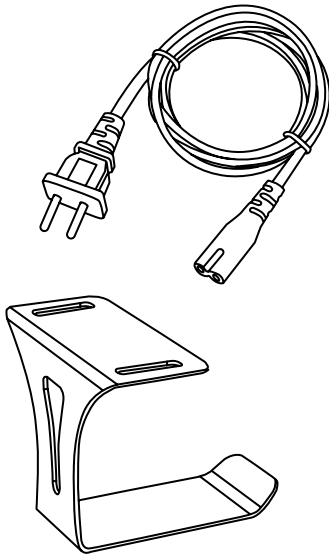
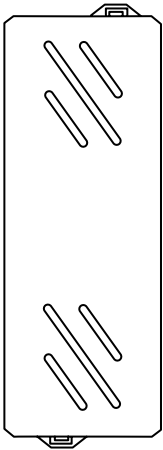
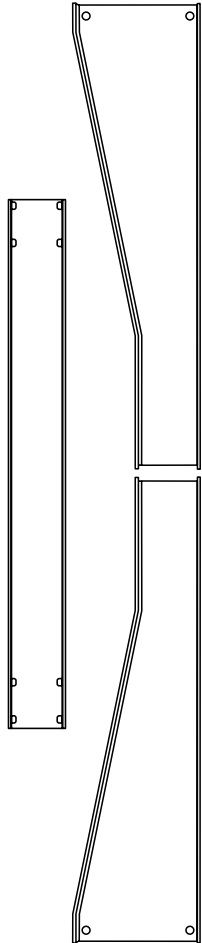
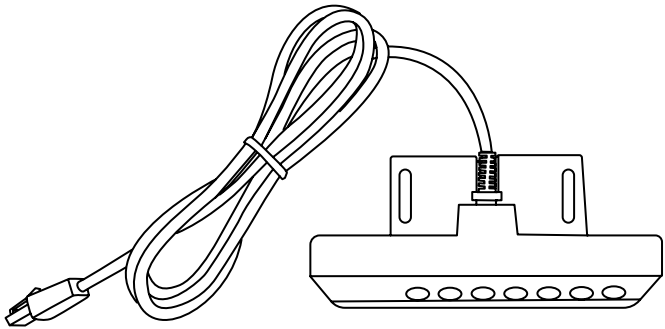

1

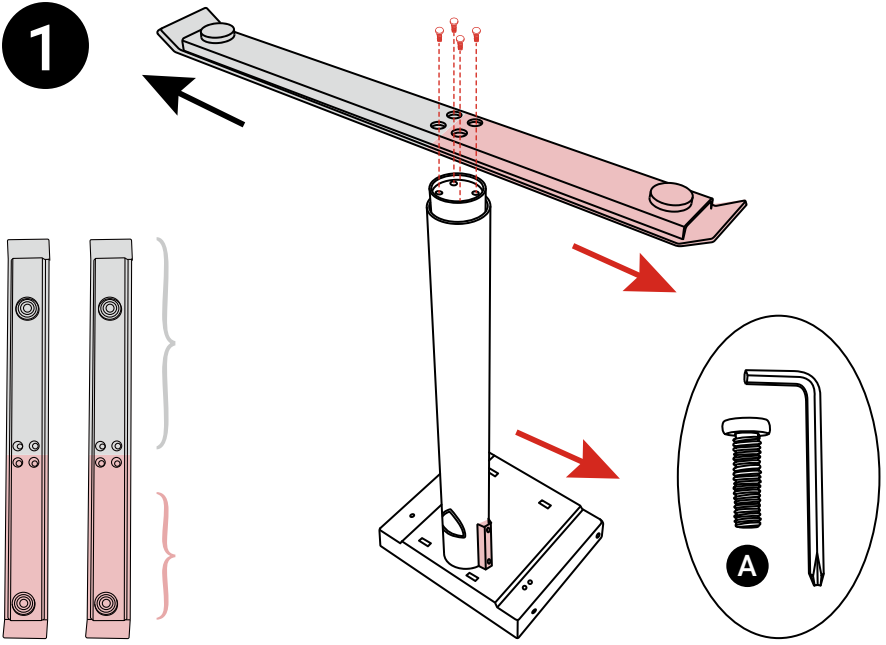

2

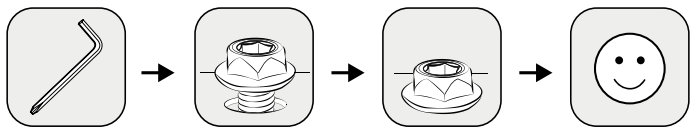
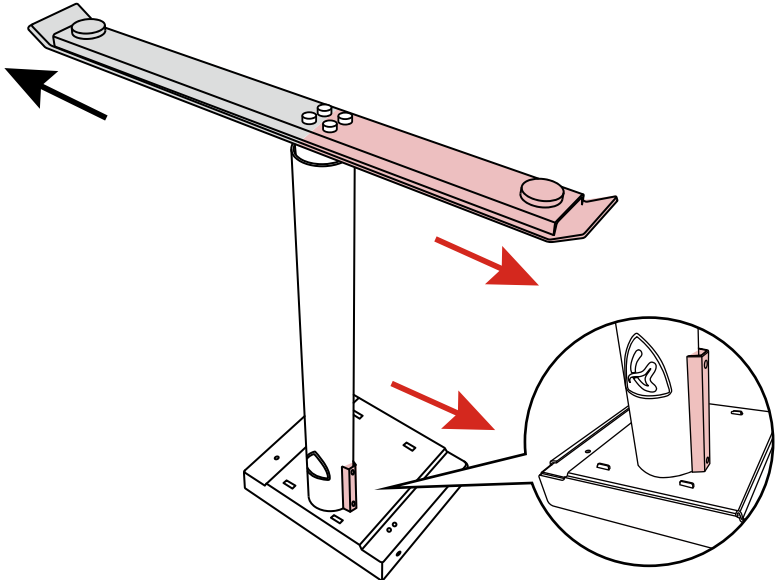



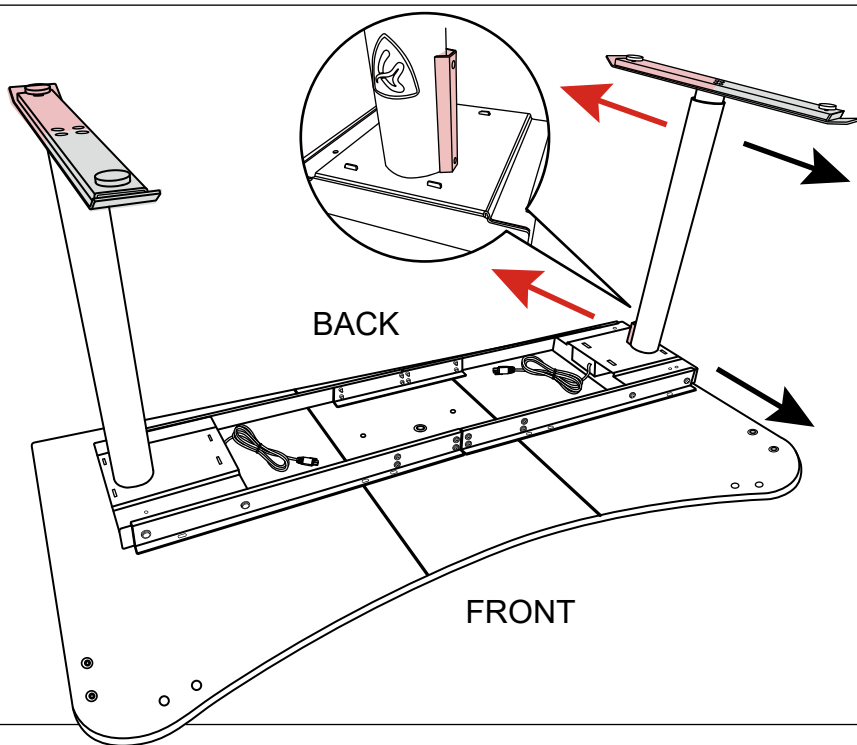

## ATTENTION!

Do not fully screw in the bolts until **step 9**. For more details, look at the video:



**3**

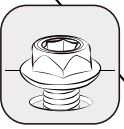
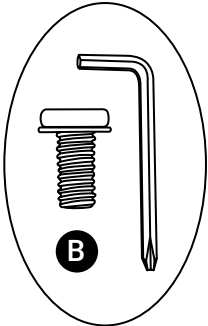
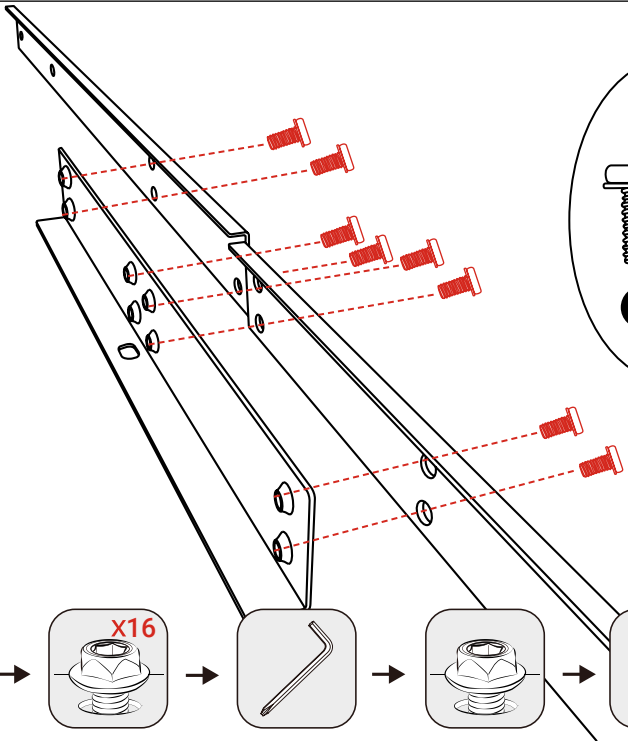

**4**

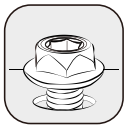
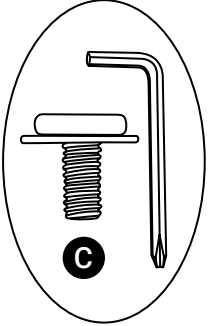
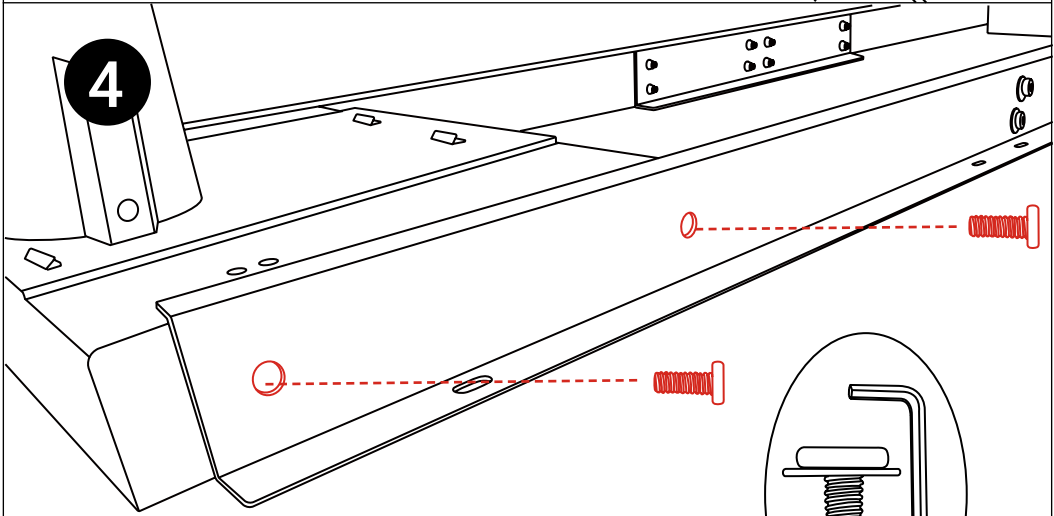

5

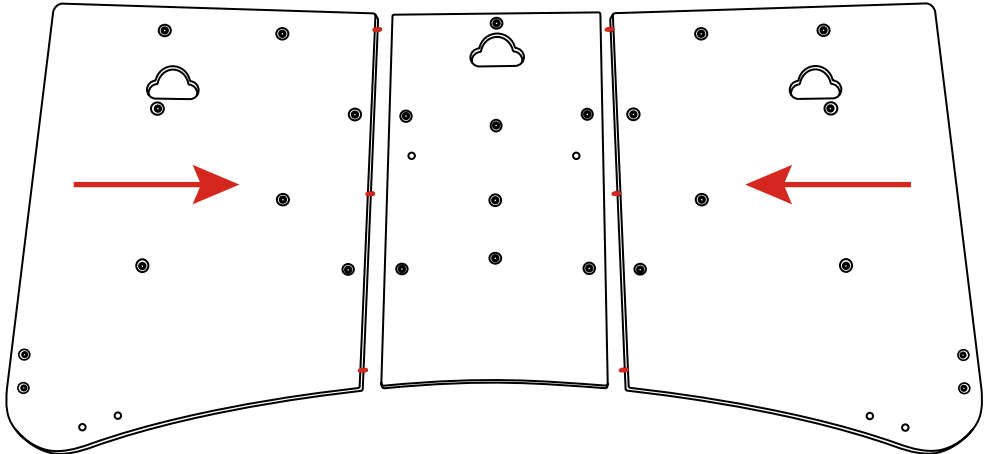

6

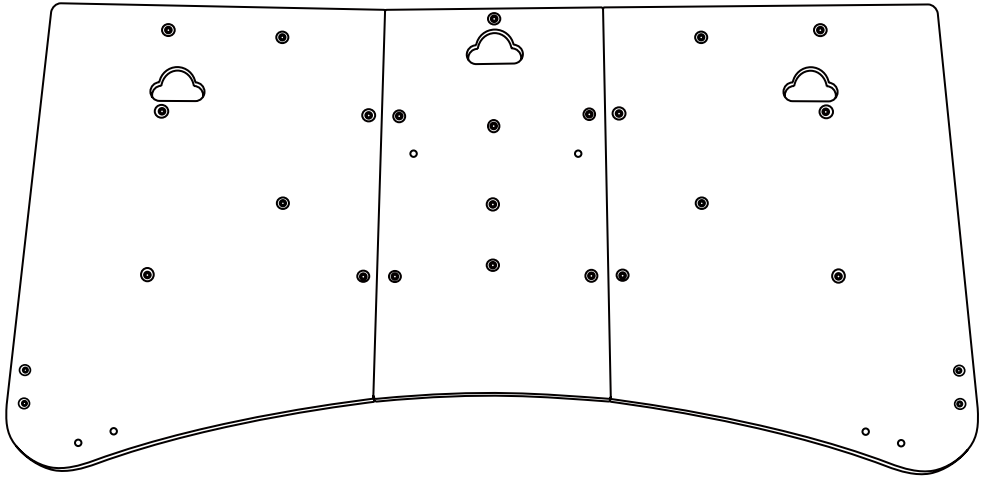

7

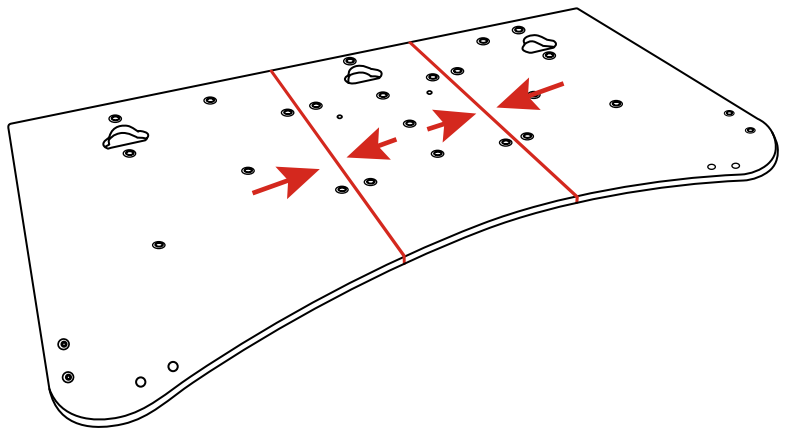
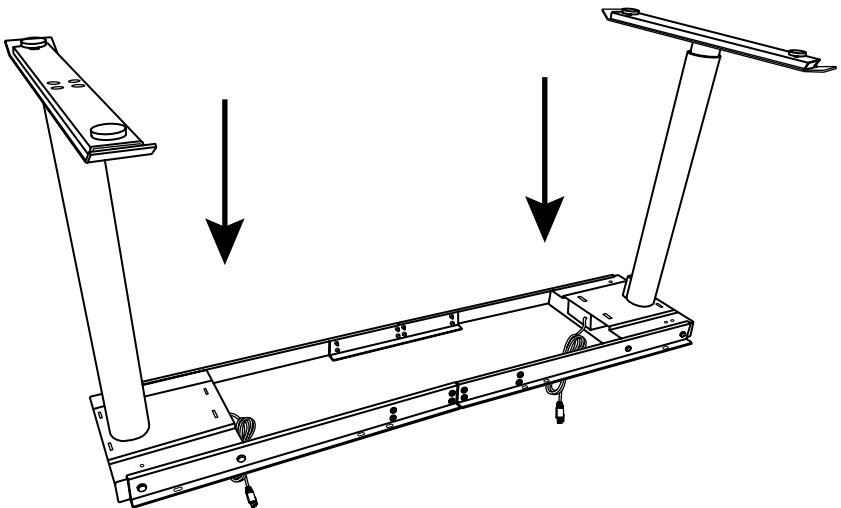

8

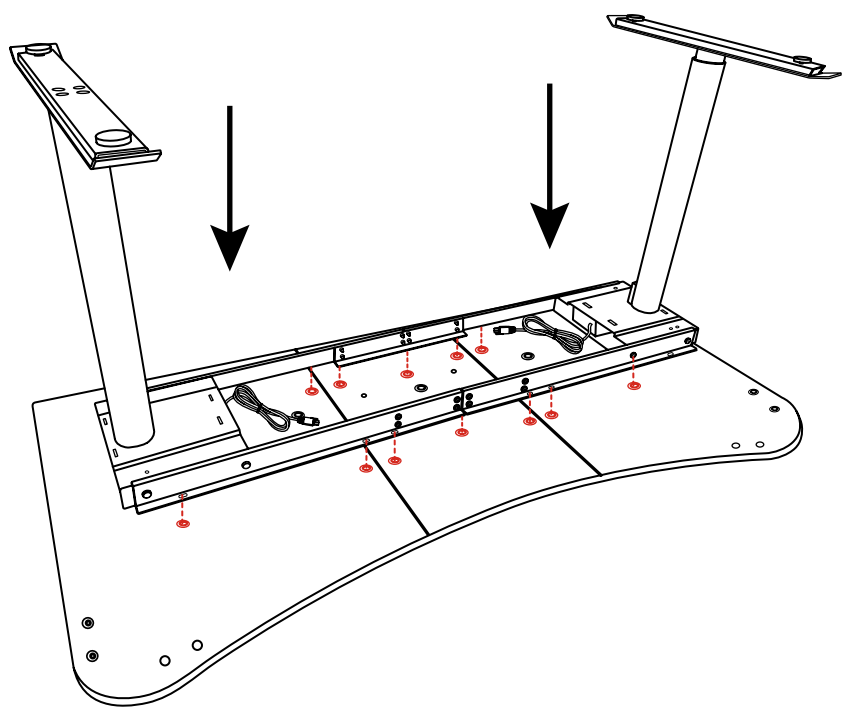

9

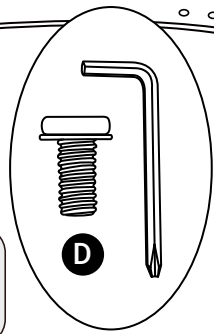
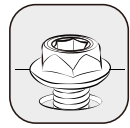
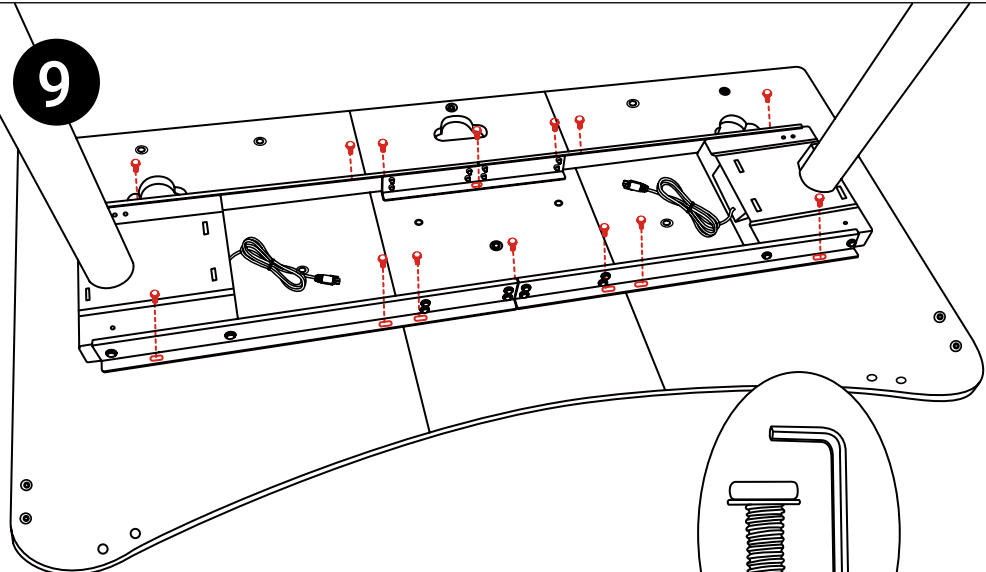

10

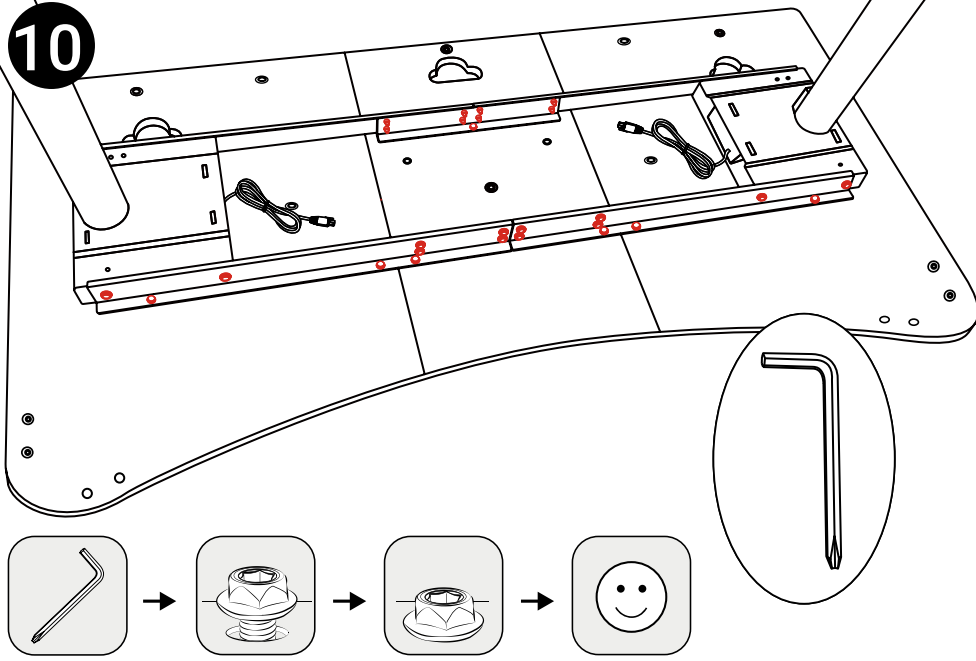

11

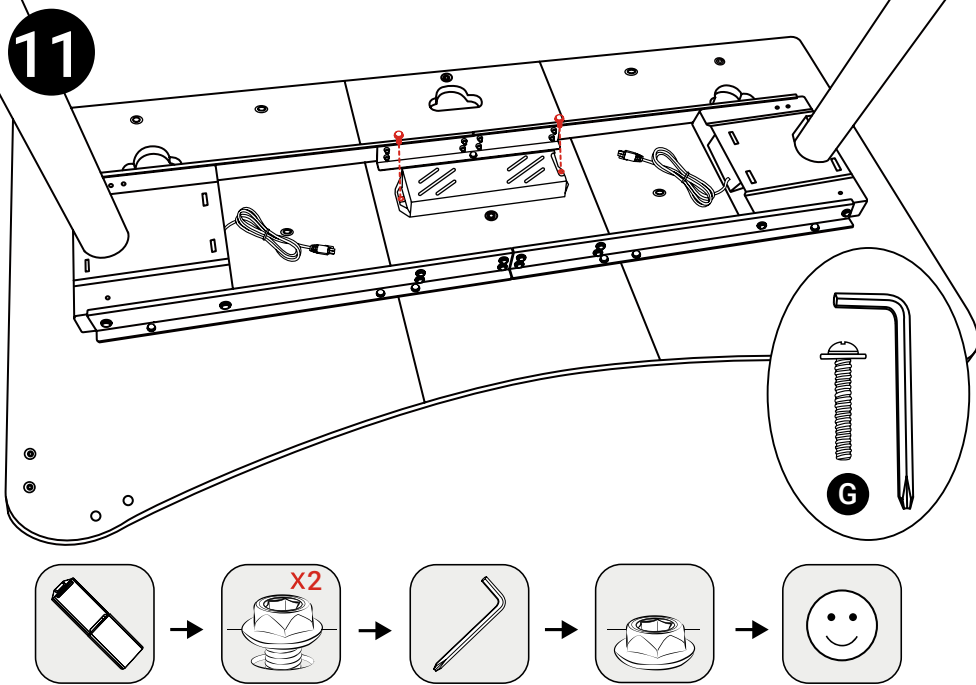

12

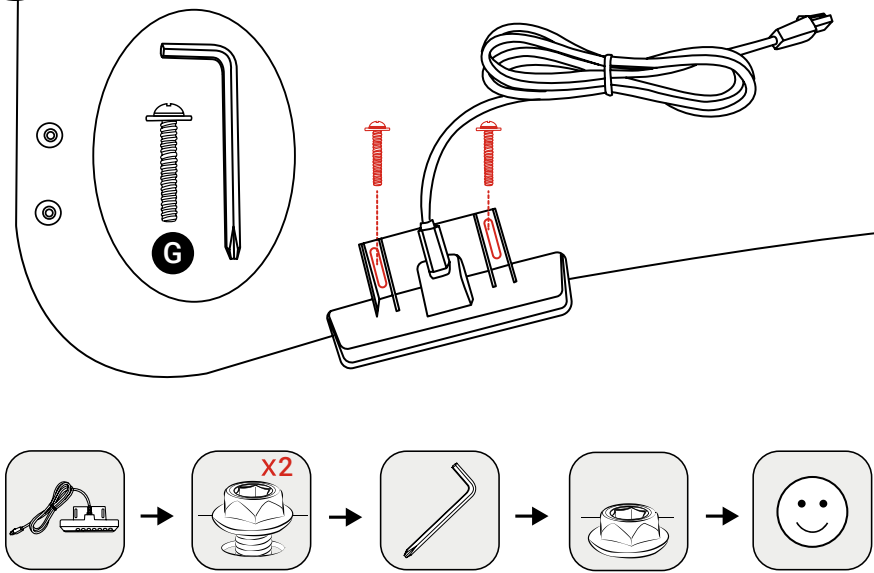

13

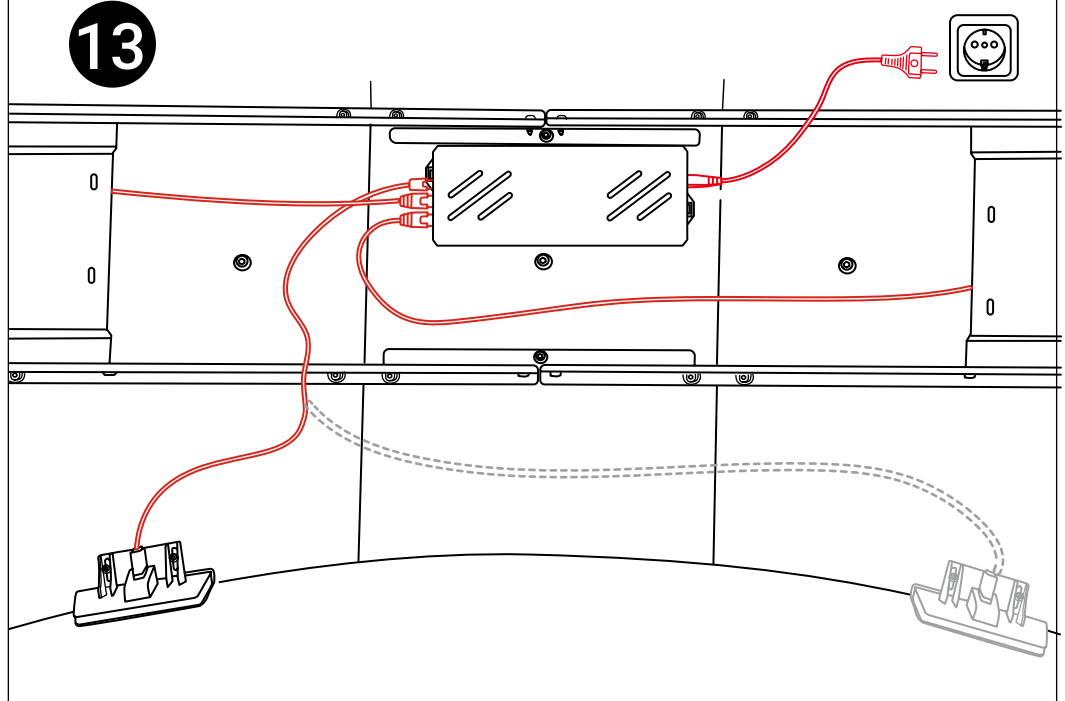

14

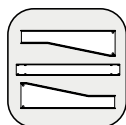
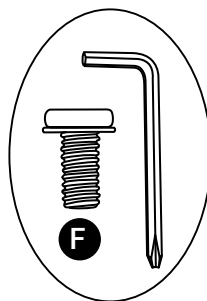
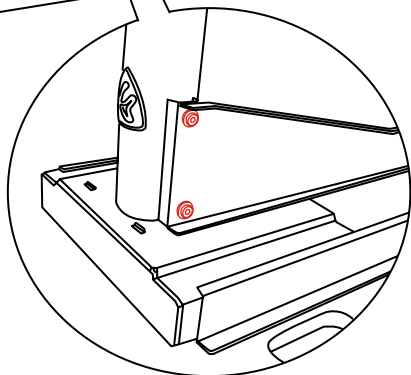
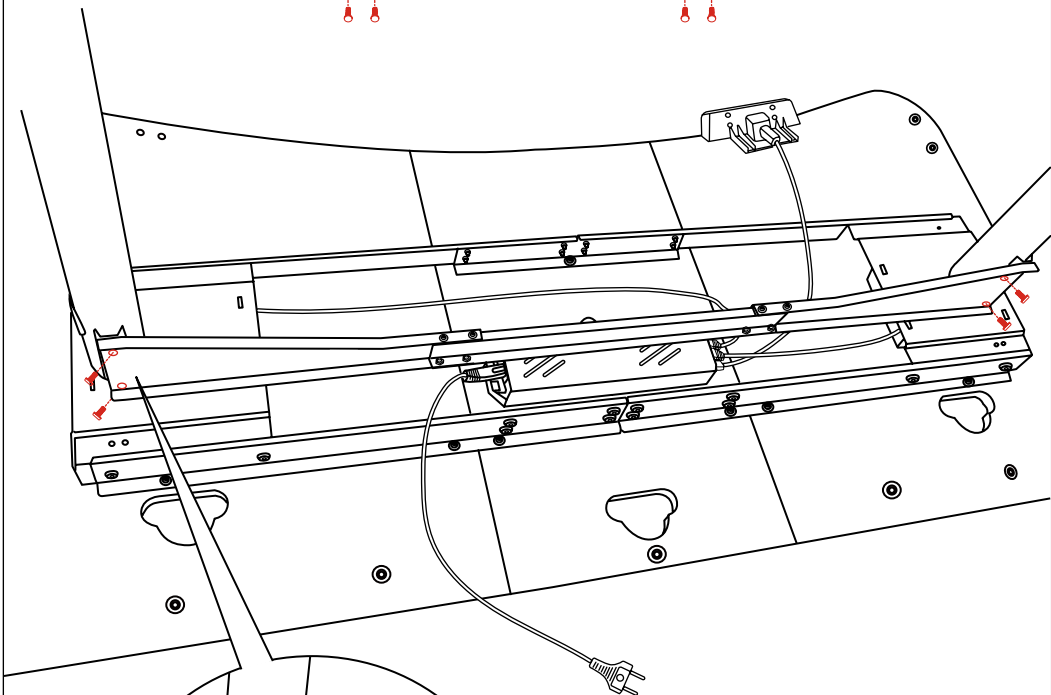
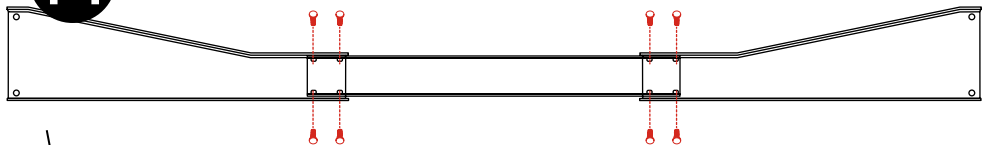



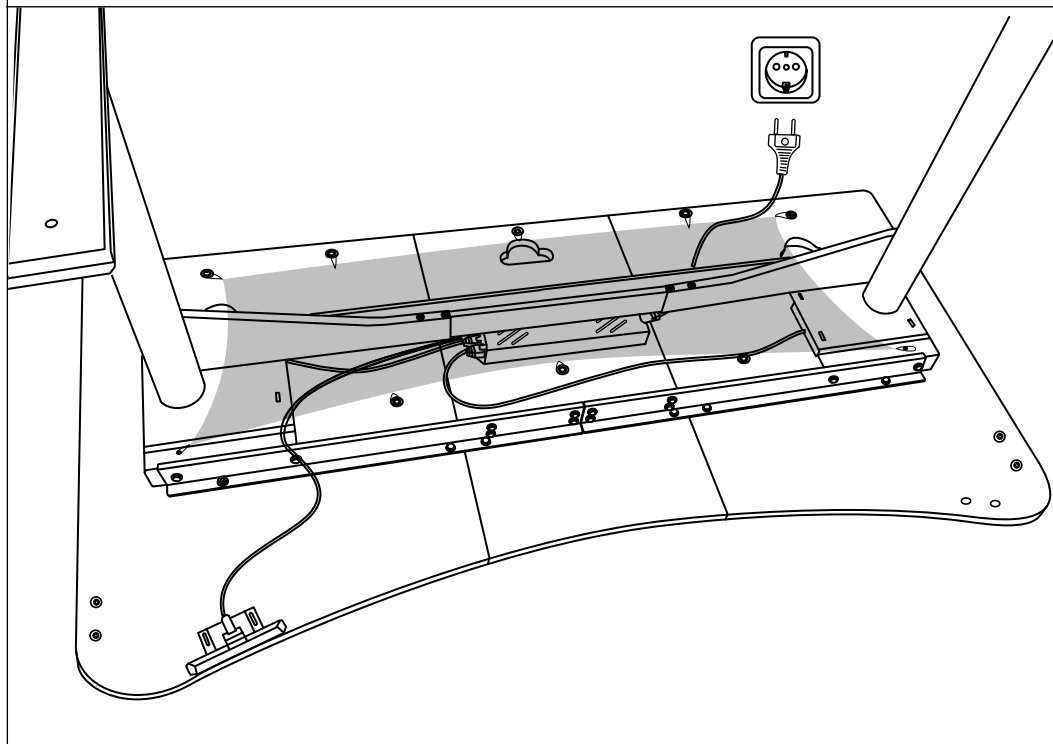
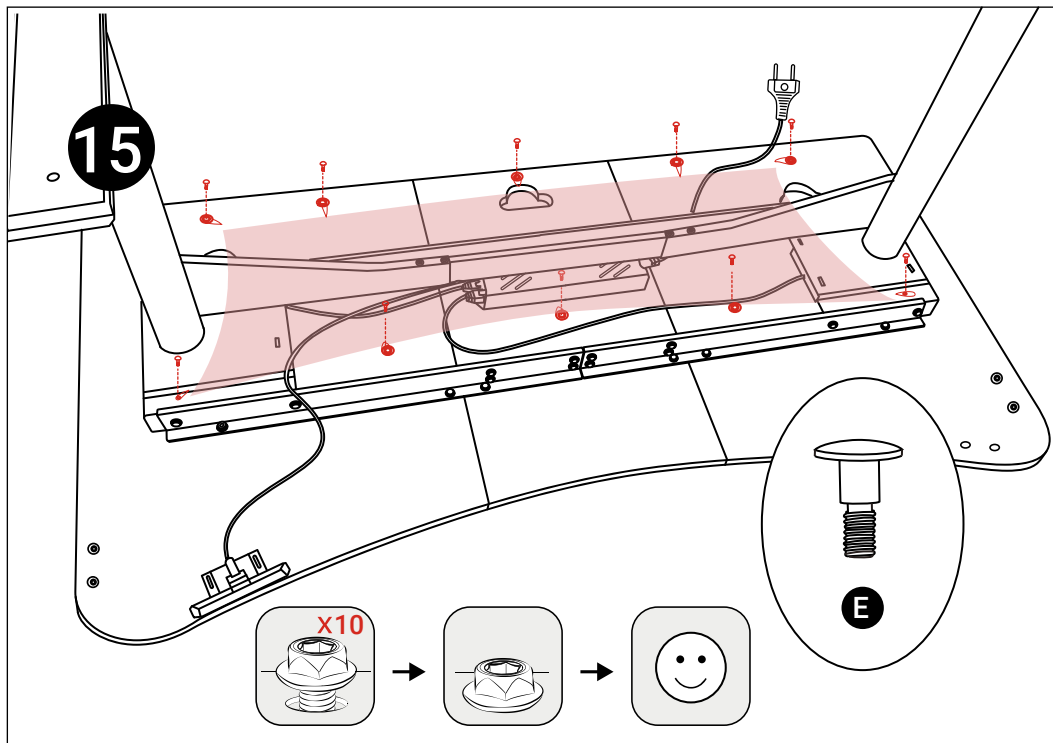

16

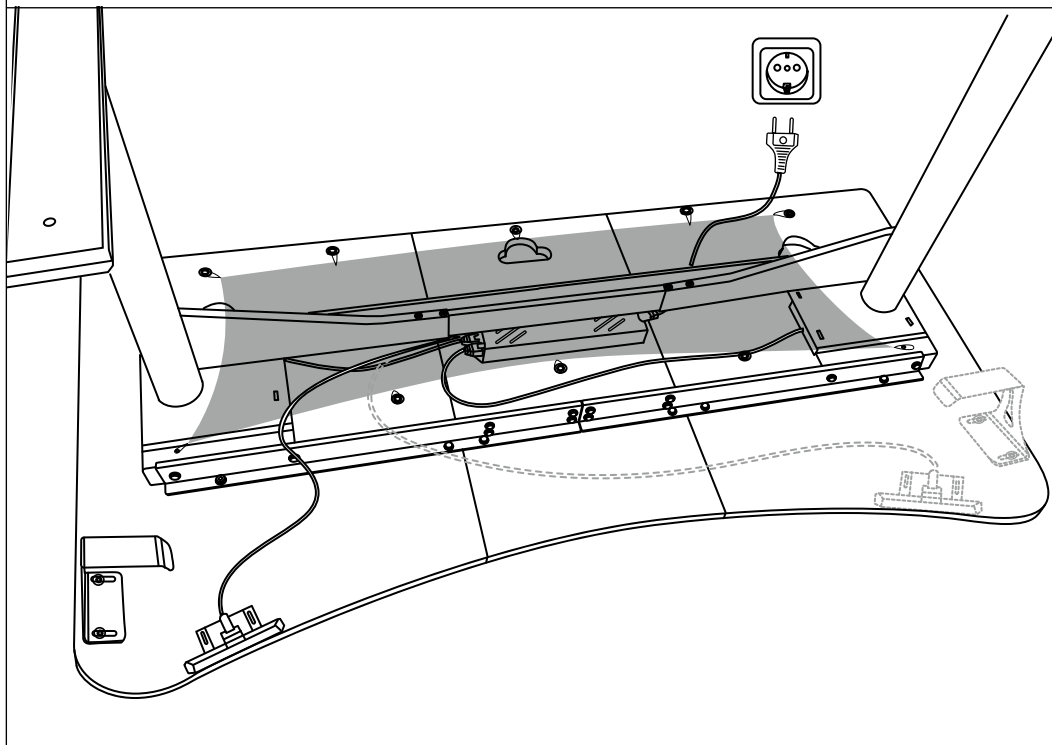
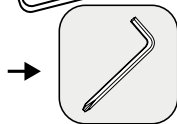
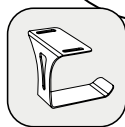
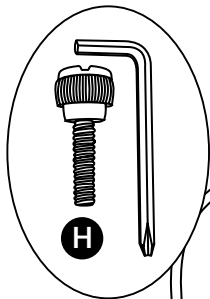
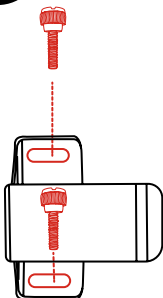

17

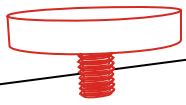
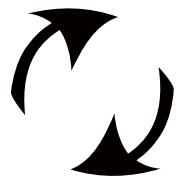

18

Arozzi

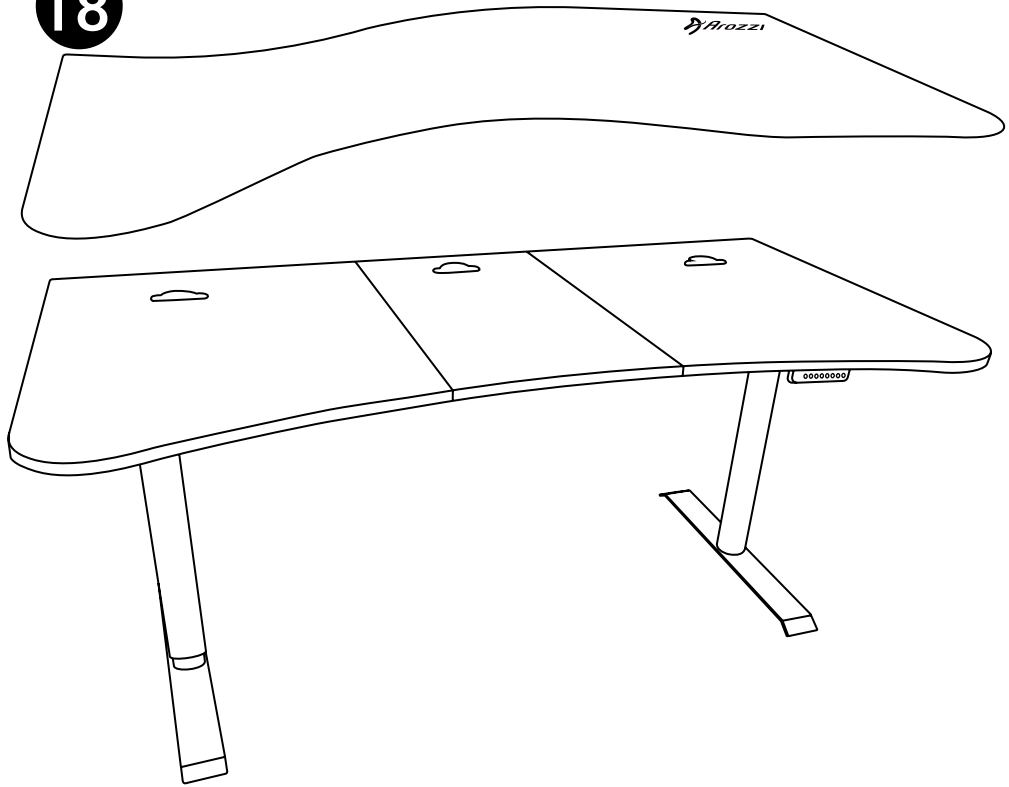

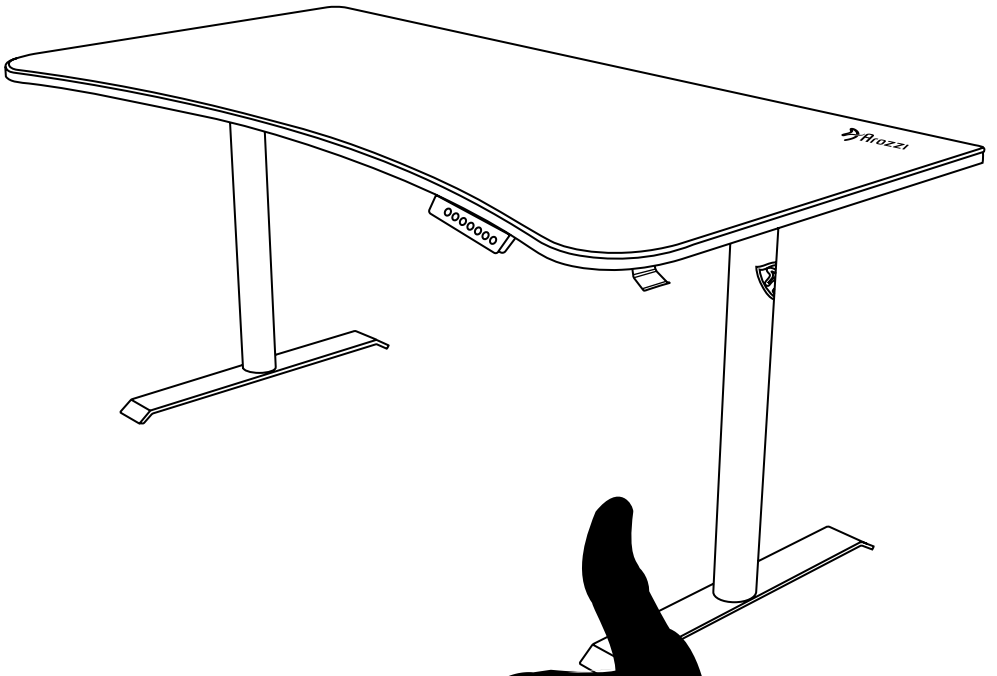

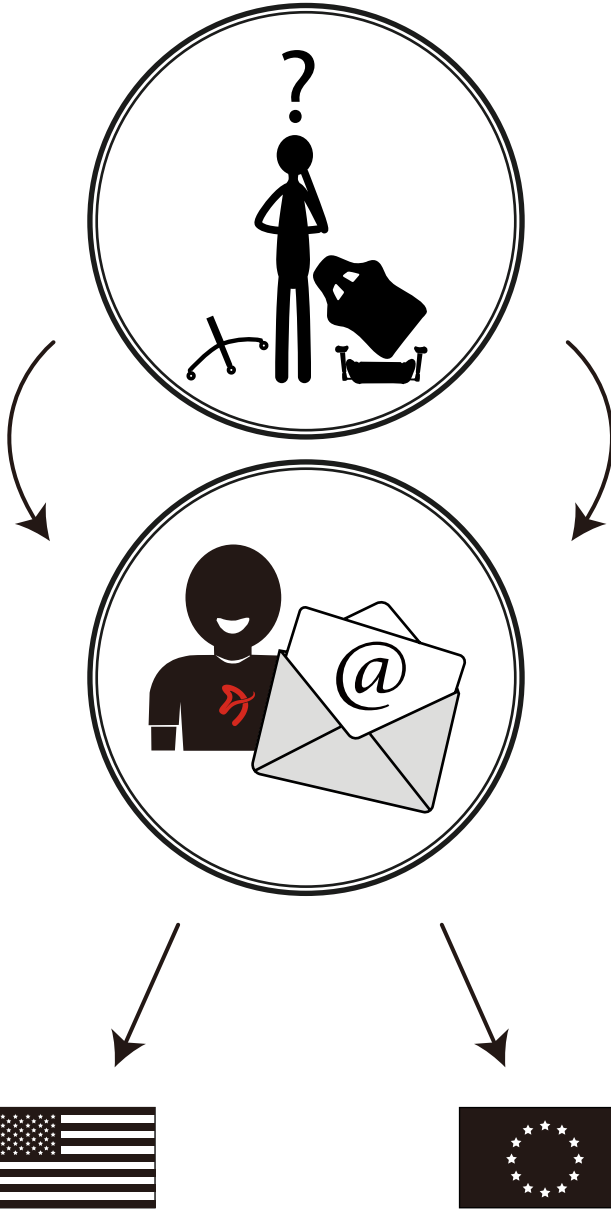

[service@arozzi.com](mailto:service@arozzi.com)

[support@arozzi.com](mailto:support@arozzi.com)

